

Note - Please take a few minutes to read this manual. This will help you assemble and use the playpen suitably. Keep this manual for future reference.

Before assembly, please double-check all parts as shown are included in the package. To guarantee the service life of the playpen, please use it correctly as per the instructions and make thorough inspections regularly. Never use it if any parts are missing or broken.

For Your Child's Health & Safety

- To prevent possible injury by entanglement, remove this toy when the child starts trying to get up on its hands and knees in a crawling position.
- Keep all small parts and packaging materials for this product away from babies and children.
- The product must be installed and used under the supervision of an adult.
- Please ensure that all parts are correctly installed.
- Check this playpen regularly before using it, and do not use it if any part is loose or missing or if there are any signs of damage. Do not substitute parts.
- The product, including side rails, must be fully erected prior to use.
- Ensure that the sides of this playpen are properly latched or locked in the appropriate position before placing a child in it.
- Do not use this playpen for a child who can climb out of it or who is taller than 90 cm.
- When a child is able to pull to a standing position, set the mattress/ base to a lower adjustment position and remove bumper pads, large toys, and other objects that could serve as steps for climbing.
- Use only the mattress/ pad provided by the manufacturer.
- Ensure that all bassinet fabric lies flat against the playard frame and that the bassinet corners are secure with the hook-and-loop strips.
- Always check that the bassinet is securely locked on the frame by pulling upwards.
- Do not place any cord, strap, or similar item in or near this accessory that could become wrapped around a child's neck.

- Ensure that the play yard is fully erected before each use.
- Check that:
 - 1.The top rails are completely locked by pushing down on them
 - 2.The center of the floor is completely pushed down
 - 3.The mattress is lying flat and is secured with all hook-and-loop straps.
- Never use the play yard on uneven or unsafe surfaces.
- Never use near stoves, heaters, or other heat sources
- Do not change, tamper with or modify any part of this product.
- Never leave Changing Table in place when the child is in the playard.

Parts & Accessories

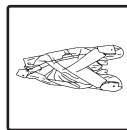

1.Playard

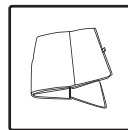

2.Mattress

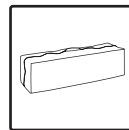

3.Co-sleeper belts x2

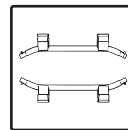

4.Short Bar with Connectors

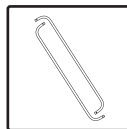

5.Curved Connector Bar

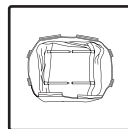

6.Large bassinet with metal support tubes

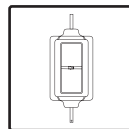

7.Changing Table

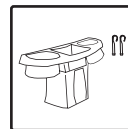

8.Parent Organizer

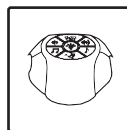

9.Music Center

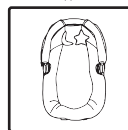

10.Portable Rock-a-Bye bassinet

Assembly Instructions

• Playpen Assembly

Step 1

1) Unzip the bag and remove the Playard frame (Fig. 1). Undo the Fasten straps and set the mattress aside. Do not push the center down yet.

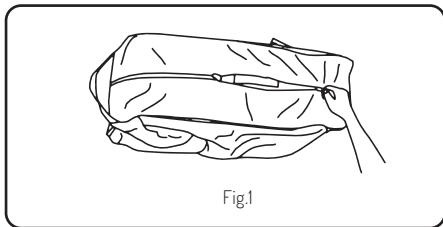

Fig.1

Step 2

2) Top rails must be fully locked before lowering the center. Pull up one rail at a time, hold one hand on each side of the rail and pull up sharply, do not pull from the middle where the center latch release is located, make sure both tubes latch in place and each rail is rigid (Fig. 2).

IMPORTANT: The center must be raised while locking the rails. If one rail will lock but the other side will not then, unlock the rail by squeezing the release in the center and try again.

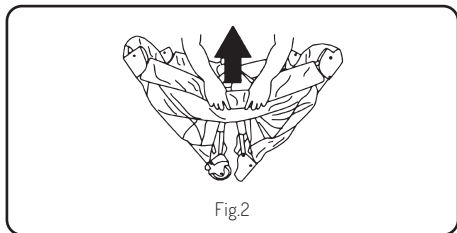

Fig.2

Step 3

3) Once all four (4) top rails are locked in place, push down on the center handle (Fig. 3a). The center mechanism automatically locks in place.

IMPORTANT: Test each top rail by pushing down slightly to confirm each is rigid and securely in place before use (Fig. 3b)

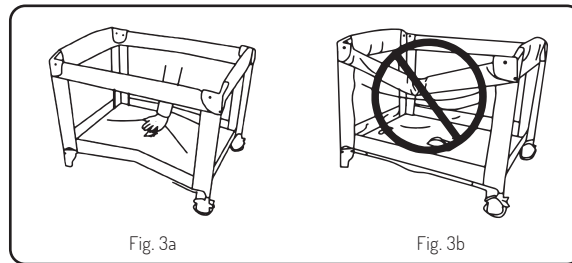

Fig. 3a

Fig. 3b

• Folding The Playard

Step 4

4) Place the Mattress on the floor of the Playard with the padded side facing up (Fig. 4).

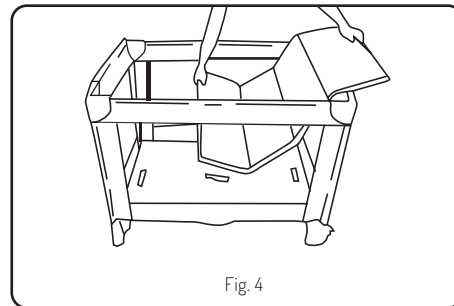
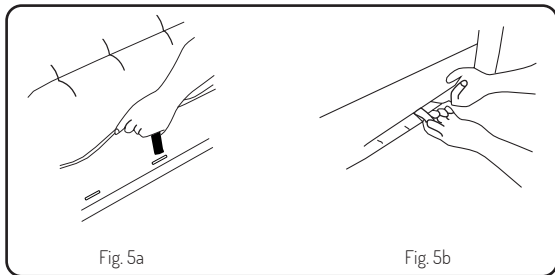

Fig. 4

Step 5

5) Insert the hook & loop fasteners located on the underside of the mattress through the slots in the floor of each end of the playard (Fig. 5a). Fasten the hook and loop fasteners to the underside of the playard floor to prevent the mattress from moving (Fig. 5b).



IMPORTANT: The handle located in the center of the Playard floor must remain raised (Approx. 45.7 cm or 18 inches) while locking the side rails in place. If the center is not raised, the rails will not lock. If you experience difficulty and one side of the rail will lock but the other side will not then unlock the rail by squeezing the release in the center and try again.

Step 6

6) To operate the brakes on the wheels, press downward on the brake levers. To release, lift upward on the lever (Fig. 6).

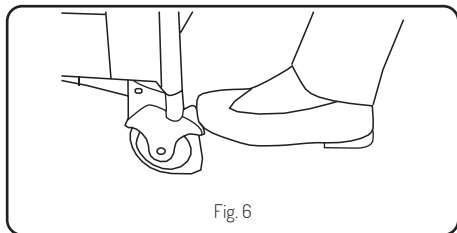

Step 7

7) Release the hook and loop fastener holding the mattress from underneath the Playard floor or the Bassinet and set the mattress aside. Do not unlock the top rails yet, the center handle must be raised before unlocking the top rails. Rotate the center handle counter-clockwise at 90 degrees and raise the center as high as the top rails (Fig. 7). Gather the legs and wheels together towards the center as close as possible.

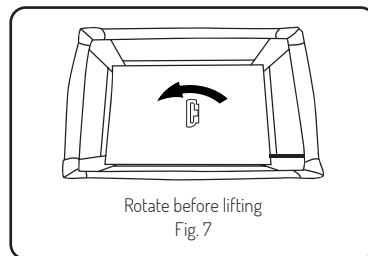

Step 8

8) Locate the rail latch release in the center and bottom side of each rail. Squeeze the lever with two hands until the rail releases the two tubes (Fig. 8a), then push down (Fig. 8b). **NOTE:** If the top rail(s) do not release completely, do not apply excessive force! Lift the center of the floor higher. Both tubes must be released for the top rail to fold.

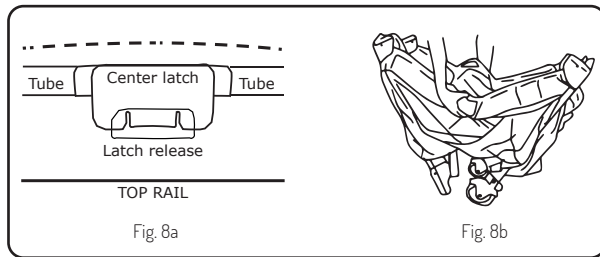

Step 9

9) Gather all four (4) corners and the center together tightly (Fig. 9). Wrap the mattress around the playard frame with the padded side facing inward.

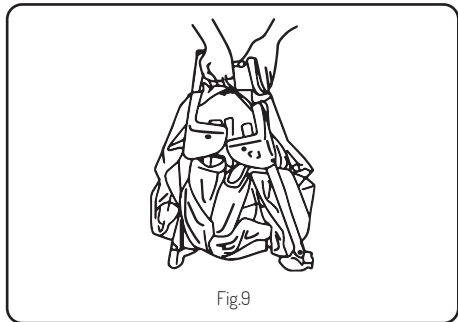

Step 10

10) Fold it up and secure it with hook and loop fasteners.(Fig. 10). Place the folded Playard into the carry bag so that the handle comes through the opening between each side of the zipper.

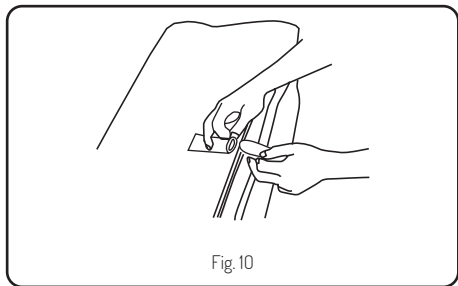

Large Bassinet Assembly

• When Assembling:

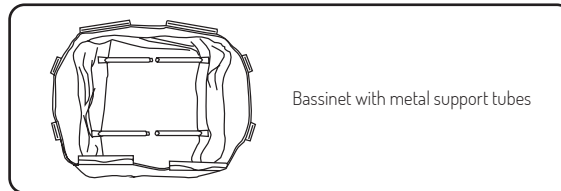

ATTENTION: Playard must be fully assembled and securely locked before installing or using the Bassinet (See To Assemble Playard section). You will need to remove the mattress from the bottom of the Playard to use inside your Bassinet.

Step 11

11) Connect opposing Mattress Support Tubes that are attached to the bottom of the Bassinet (Fig. 11a). Before placing the mattress into the Bassinet, make sure the mattress support tubes are connected (Fig. 11b).

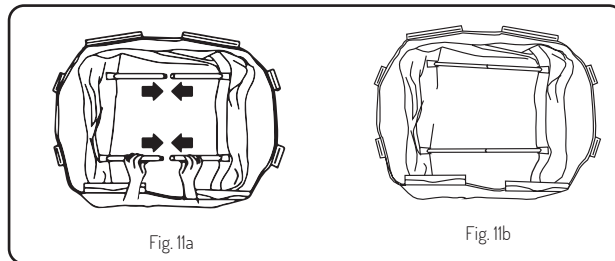

Step 12

12) Position the bassinet over and down into the fully assembled Playard. Secure in place by pushing down firmly on each plastic support clip until all are snapped into place (Fig. 12).

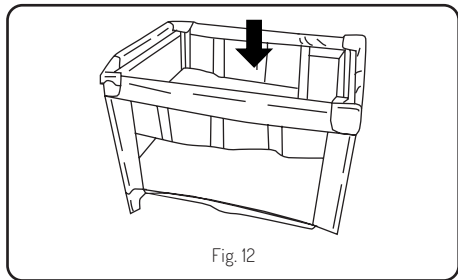

Fig. 12

Step 13

13) Place the Mattress into the bassinet with the padded side facing upward (Fig. 13).

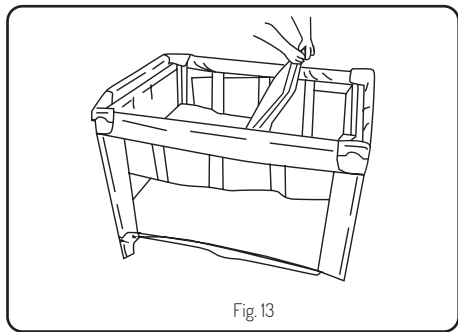

Fig. 13

• When Assembling:

Remove the mattress from the bassinet. Disconnect opposing mattress support tubes. Unsnap all clips and lift the bassinet.

• Changing Table Assembly

ATTENTION: Playard and large bassinet must be fully assembled and securely locked before installing or using the changing table (See To Assemble Playard and large bassinet section)

Changing Table Assembly will require the following parts:

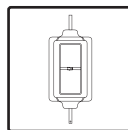

1.Changing Table

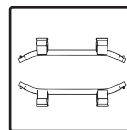

2.Short Bar with Connectors

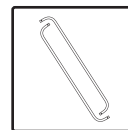

3.Curved Connector Bar

Step 14

14) Lay the changing table cover on a flat surface with the backside facing up. Locate the 2 Curved Connector Bars (Fig. 14a). Insert the Curved Connector Bars into the backside of the Changing Table covering (Fig. 14b).

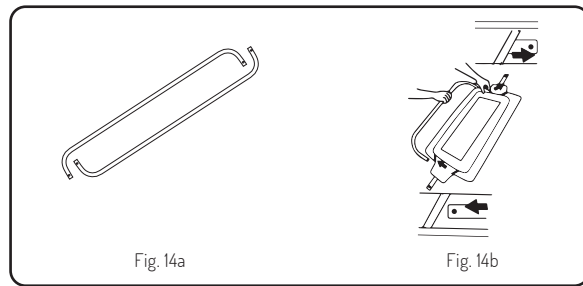
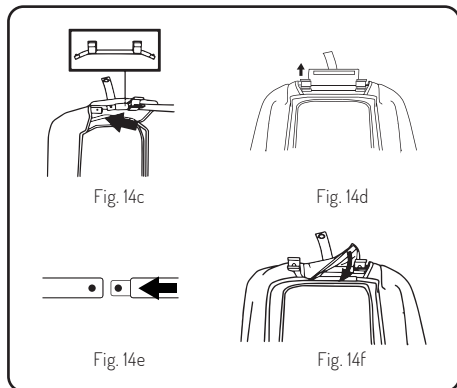

Fig. 14a

Fig. 14b

Attach the Short Bars with the 2 Connectors to the Curved Connector Bars (Fig. 14c). Be sure the clips are faced up during this preparation on the backside of the changing table covering (Fig. 14d). Insert both ends with the push pins into the Curved Connector Bars. Ensure all pins click into position on all 4 connection points (Fig. 14e).

Close the covering by using the hook and loop fasteners on the flap. Flip the flaps over the bars and fasten them together (Fig.14f).



Attaching the Changing Table to the Playard

IMPORTANT! When the changing table is in the upper position the changing table must be secured to the playard frame by using the snap buttons, straps or fasteners provided.

Step 15

15) Locate the 4 clip fasteners on the bottom of the changing table (Fig. 15a).

To attach the changing table to the playard, lower the changing table into the large bassinets. Push down on the 4 clips to secure them onto the large bassinets railing (Fig. 15b). Secure the two snaps on the strap down onto the Playard (Fig. 15c).

NOTE: Do not use changing table on the playard without the large bassinets (Refer to assemble large bassinets section) and secure the clips to the playard.

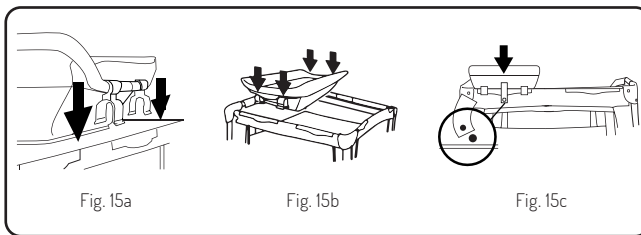

Using the Changing Table Safety Belt

Step 16

16) Place the child on the changing table, and make sure hands and arms are clear of the belt.

Bring the belt around the child's waist and clip the male and female ends of the buckle together (Fig. 16a).

Tighten the strap until it fits snugly around the child's waist (Fig. 16b). Do not over-tighten. To remove, unsnap the buckle.

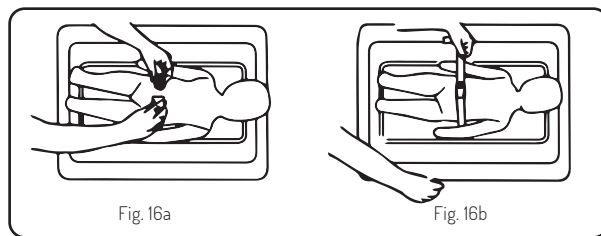

Removing the Changing Table

Step 17

17) Unsnap from the playard (Fig. 17a). Locate all clips/fasteners on the changing table. Pull up all clips to release them from the playard frame (Fig. 17b).

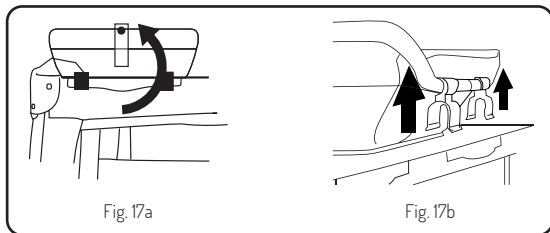

• Parent Organizer Assembly

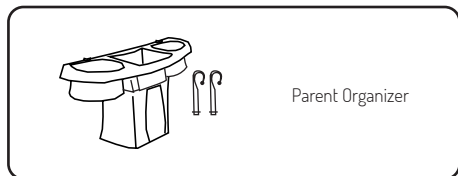

Step 18

18) Parent Organizer: Position each hook so that the hooked end is facing the rear side of the organizer. Press the hook down firmly into the slot until it snaps into place (Fig. 18a). Diaper Stacker: Skip to step 18b.

Connect the Parent Organizer/Diaper Stacker to the Playard by sliding the connecting clips over an open portion of the top rail of the Playard (Fig. 18b).

NOTE: The Parent Organizer / Diaper Stacker can only be installed on open sides of the Playard where the connecting clips can easily be attached without interfering with other features.

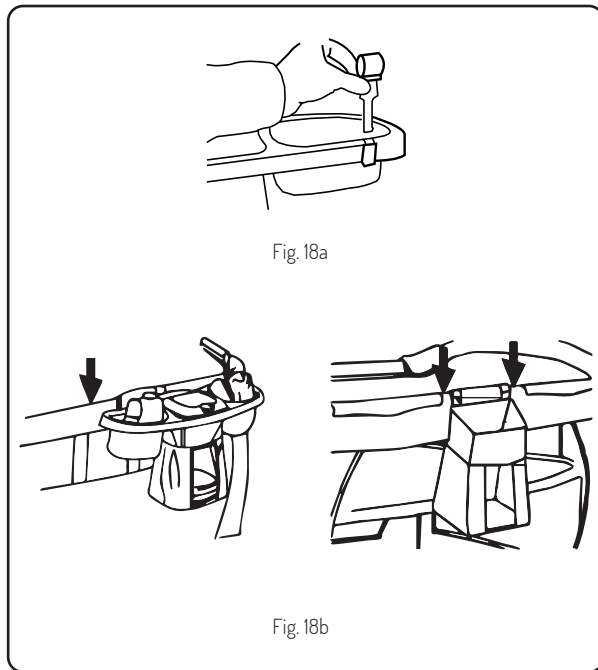

Assembling Bassinet with Rocking Function

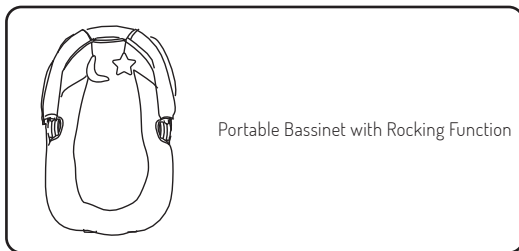

Step 19

19) Put the napper on a flat surface with the carry handle on the underside. Unfold each bar into its vertical position. Each bar should lock into place automatically (Fig. 19a). Make sure each bar is firmly locked into place by pushing/pulling on it.

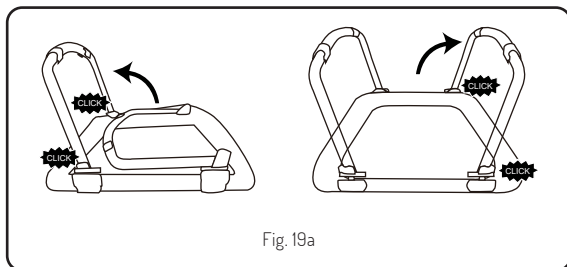

Step 20

20) Extend each foot (x4) on both bars (Fig. 20a).

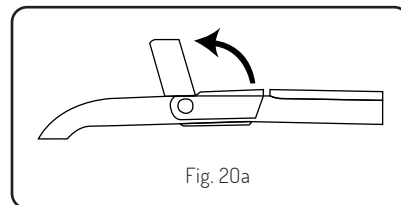

Rotate the entire napper and stand it on the foot extensions (Fig. 20b). Ensure that the napper is level and stable.

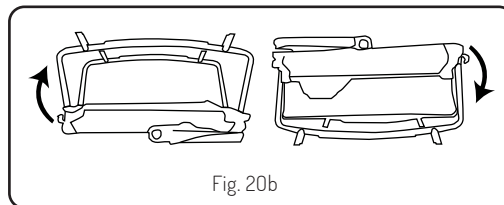

To fold napper bars: Push both buttons on each side of the bar while pushing the bar downwards. Repeat for the other bar (Fig. 20c).

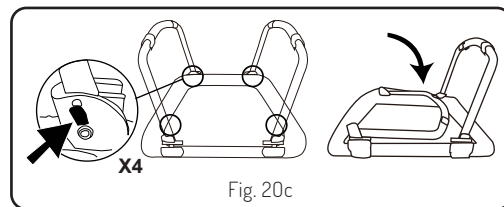

Step 21

21) The rear of the canopy has 2 fabric openings. Pull both openings over the 2 clips at the rear of the bassinet frame.

Ensure to wrap the elastic completely over the bassinet frame (Fig. 21a).

NOTE: Always complete the canopy before attaching the bassinet to the playard frame.

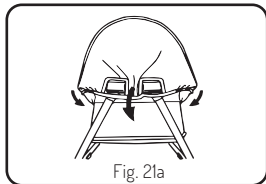

Fig. 21a

To raise the handle, push both buttons on each side of the handle with your fingers while pulling it forward (Fig. 21b).

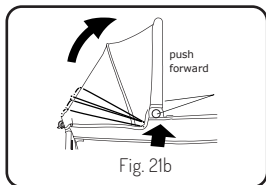

Fig. 21b

To lower the handle, push both buttons on each side of the handle with your fingers while pushing the handle backward (Fig. 21c).

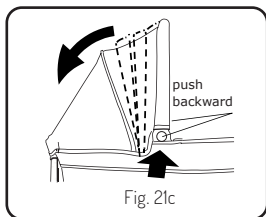

Fig. 21c

Rocker Function

Step 22

22) Turn the bassinet over and close the 4 peg legs (Fig. 22a). Set Bassinet on a flat surface (Fig. 22b).

NOTE: Rocking requires adult assistance and supervision, this is not an automatic rocking cradle (Fig. 22c).

Never use the bassinet on raised surfaces such as Table, Bed, or Chair. A fall can occur.

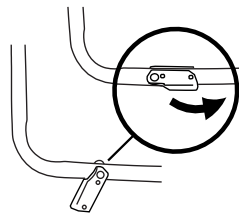

Fig. 22a

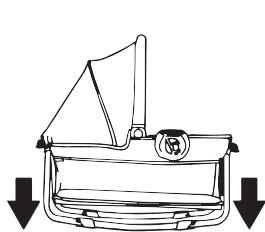

Fig. 22b

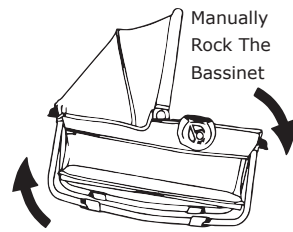

Fig. 22c

Attaching the Portable Rocking Bassinet to the Playard

IMPORTANT! When the rocking bassinet is in the upper position, it must be secured to the playard frame by using the snap buttons, straps, or fasteners provided.

Step 23

23) Locate the 4 clip fasteners on the bottom of the rocking bassinet (Fig.23a). To attach the Rock-A-Bye Bassinet to the Playard, lower it into the large bassinet. Push down on the clips and secure them onto the large bassinet railing (Fig. 23b). Secure the two snaps on the strap down onto the Playard (Fig. 23c).



Fig. 23a

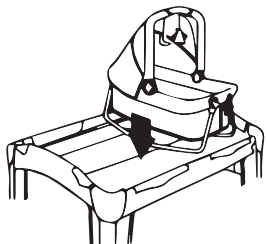

Fig. 23b

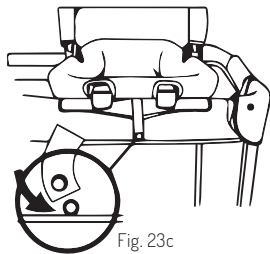

Fig. 23c

Step 24

ATTENTION: Playard and large bassinet must be fully assembled and securely locked before installing or using the portable rocking bassinet. (Refer To Assemble Playard and large bassinet sections).

Reverse the step above to remove the rocking bassinet.

24) Remove the Portable Rocking Bassinet from the Playard and place it on a flat surface (Fig. 24).

To Fold: Reverse the previous Assembly of the rocking bassinet section.

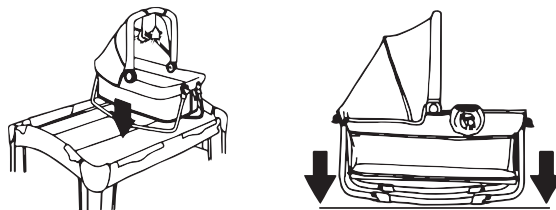

Fig. 24

Music Center Operation

WARNING: Keep batteries out of children's reach. Old and new batteries should not be mixed.

Alkaline, standard carbon-zinc and rechargeable nickel-cadmium batteries should not be mixed.

Remove batteries before storing the music center for a long period of time.

Step 25

25) The Music Center is designed to be attached to the playard's/bassinets long rail (Fig 25).

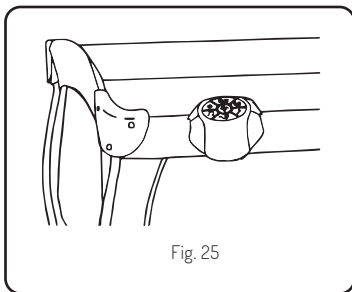

Fig. 25

Music Operation

Step 26

26) The Music Center requires 4 AA batteries. Please see figure 26 for battery installation. Unscrew the battery door screws and pull them outward on the battery door. Install batteries as shown. Re-install the battery door and secure it with screws.

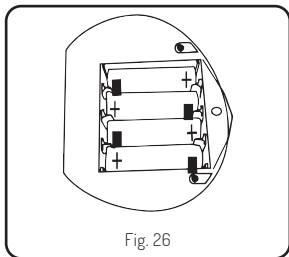

Fig. 26



To listen to MUSIC, press the MUSIC button. Press the button to change the song.



To listen to NATURE sounds, press the NATURE button. Press the button to change the sound.



To listen to SLEEP music, press the SLEEP button. Press the button to change the song.



These 2 buttons control the unit's volume.



VIBRATION: To use the VIBRATION, press down the VIBRATION button once to activate the speed, and press again for faster speed. Press it again to reduce the speed.



NIGHT LIGHT: To use the night light, press the NIGHT LIGHT button.

Cleaning Instructions

Use only mild soap and warm water.

Do not use bleach.

Do not machine wash.